

- P L C
- H M I
- SENSOR
- ENCODER
- COUNTER
- INFORMATION

# TRD-MX Series

## Features

### φ25 Incremental Type

Ultraminiature design with outside diameter of φ25 mm/ depth of 29 mm/ shaft diameter of φ4 mm  
 Small diameter lineup with resolutions up to 1,024 P/R. Line driver output is available.

- Pulse number: 100, 200, 360, 500, 512, 600, 1,000, 1,024P/R
- Supply voltage: 5 to 24 V DC
- Maximum allowable number of revolutions: 6,000 rpm
- Output signal format: 2-phase output + Origin
- Output form: NPN open collector / line driver
- IP50 (Dustproof type)



### Model Number List

Type	Appearance	Model Number	Supply Voltage	Output	Output Form	Pulse Number / Rotation
Shaft Type		TRD-MX□A	4.5 to 13.2 V DC	Output with 2-phase origin (Origin reverse action □)	Open collector output	100, 200, 360, 500, 512, 600, 1,000, 1,024
		TRD-MX□B	10.8 to 26.4 V DC			
		TRD-MX□V	4.75 to 5.25 V DC	Output with 2-phase origin (Origin direct action □)	Line driver output	

**TRD-MX** □ **A**

- Series classification
- Pulse number
- Form

- A:** Supply voltage 4.5 to 13.2 V DC    Open collector output
- B:** Supply voltage 10.8 to 26.4 V DC    Open collector output
- V:** Supply voltage 4.75 to 5.25 V DC    Line driver output

### Pulse and Frequencies

Pulse Number per Rotation	100	200	360	500	512	600	1,000	1,024
Maximum Response Frequency (kHz)*	10	20	36	50	50	60	100	100
Applicable Models	TRD-MX□A	●	●	●	●	●	●	●
	TRD-MX□B	●	●	●	●	●	●	●
	TRD-MX□V	●	●	●	●	●	●	●

\* The electric maximum response frequency is specified by resolution (pulse number) and the maximum number of revolutions.  
 Electrical maximum number of revolutions = ((Maximum response frequency/Resolution) x 60)  
 Therefore, if the encoder rotates at a speed greater than the electrical maximum number of revolutions, the signals do not electrically follow.

- TRD-MX
- TRD-S/SH
- TRD-2E
- TRD-N/NH
- TRD-J
- TRD-GK

### Electrical Specifications

Model Number	TRD-MX□A		TRD-MX□B		TRD-MX□V		
Power Supply	Supply Voltage	4.5 to 13.2 V DC		10.8 to 26.4 V DC		4.75 to 5.25 V DC	
	Allowable Ripple	3% rms or less					
	Consumption Current (No Load)	50 mA or lower					
Output Waveform	Signal Format	2-phase output + home position					
	Maximum Response Frequency	(Maximum Response Frequency/Resolution) x 60					
	Duty Ratio	50 ± 25%					
	Phase Difference Width	25 ± 12.5%					
	Signal Width at Home Position	100 ± 50%					
Output	Rise / Fall Time	Not larger than 2 μs (Cable length 1 m, maximum load)					
	Output Form	NPN open collector output			Line driver output*		
	Output Logic	Negative logic (Active low)			Positive logic (Active high)		
	Output Voltage	"H"	—			2.5 V or higher	
		"L"	0.4 V or lower			0.5 V or lower	
	Output Current	Influx	Up to 30 mA			Up to 20 mA	
		Outflow	—			—	
Load Supply Voltage	30 V DC or lower						

\* Equivalent to 26C31. The receiver is equivalent to 26C32.

# TRD-MX Series

## Specifications/Dimensions

- PLC
- HMI
- SENSOR
- ENCODER
- COUNTER
- INFORMATION

- Rotary Encoder Lineup
- Selection Guide
- Incremental Type
- Absolute Type

- TRD-MX
- TRD-S/SH
- TRD-2E
- TRD-N/NH
- TRD-J
- TRD-GK

### Mechanical Specifications

Starting Torque	0.001 N·m or less (20°C)
Moment of Inertia	$1 \times 10^{-7} \text{ kg} \cdot \text{m}^2$
Shaft Allowable Load	Radial: 10 N
	Thrust: 5 N
Maximum Allowable Number of Revolutions (Note 1)	6,000 rpm
Cable	Outside diameter $\phi 5 \text{ mm}$ 5-core shielded oil-resistant vinyl chloride cable Core wire nominal cross-sectional area: 0.14 mm <sup>2</sup> (Line driver output is 8 cores, 0.14 mm <sup>2</sup> )
Weight	Approx. 80 g

Note 1: Maximum number of revolutions that can be mechanically endured

### Environmental Requirements

Use Ambient Temperature	-10 to +70°C
Storage Ambient Temperature	-25 to +85°C
Use Ambient Humidity	35 to 85% RH (No condensation)
Withstand Voltage	Excluded due to capacitor grounding
Insulation Resistance	20 MΩ or higher
Vibration Resistance (Endurance)	Displacement half amplitude: 0.75 mm, 10 to 55 Hz, 3 axial directions, each 1 h
Impact Resistance (Endurance)	490 m/s <sup>2</sup> 11 ms, each 3 times in 3 axial directions
Protective Structure	Dustproof type: IP50

### Output Waveform

#### Open Collector

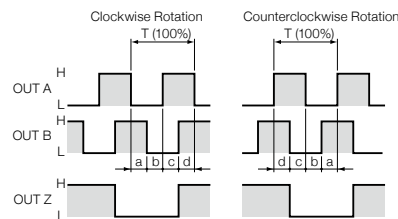

### Output Circuit

#### Open Collector

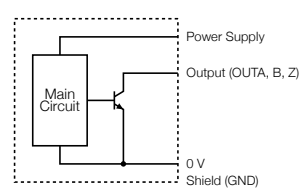

### Connection Diagram

#### Open Collector

The shielded wire is connected to the main body.

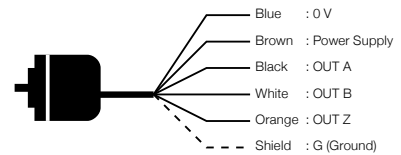

### Line Driver

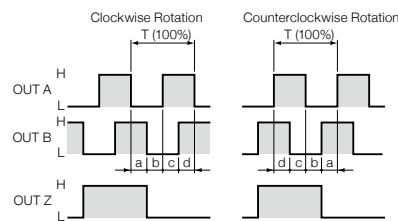

$a, b, c, d = 1/4T \pm 1/8T$

Note: Clockwise rotation when the main body is seen from the axle side is the normal rotation.

### Line Driver

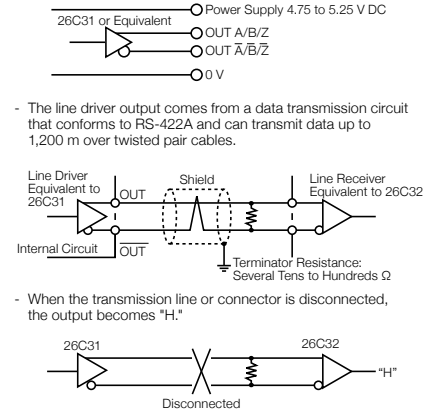

### Line Driver

The shielded wire is connected to the main body.

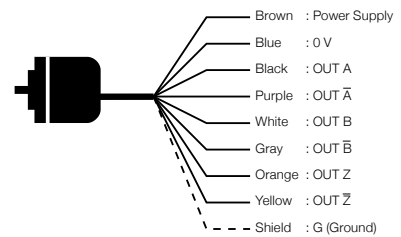

### Dimensions

(Unit: mm)

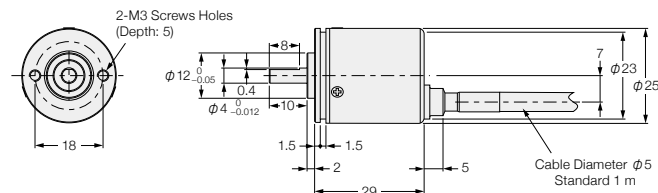

### Attachment Bore Processing Dimension Diagram

(For servo mount metal fixture)

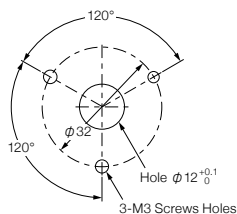

### Attachment Bore Processing Dimension Diagram

(For 2 holes)

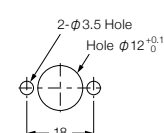

### Servo Mount Metal Fixture MM-4

(Option)

